







| MOTOFINO MF QT-21 |      |                                 |       |                             |
|-------------------|------|---------------------------------|-------|-----------------------------|
| PART NUMBER       | REF. | DESCRIPTION                     | MSRP  | PRODUCT CODE                |
| 150-21-001-000    | 1    | FRONT PANEL                     | 59.95 | 1 5 0 - 2 1 - 0 0 1 - 0 0 0 |
| 150-21-003-000    | 3    | FRONT HEAD COVER                | 49.95 | 1 5 0 - 2 1 - 0 0 3 - 0 0 0 |
| 150-21-007-000    | 7    | BACKPART,FRONT HEAD             | 49.95 | 1 5 0 - 2 1 - 0 0 7 - 0 0 0 |
| 150-21-009-000    | 9    | LEFT SIDE BOARD                 | 39.95 | 1 5 0 - 2 1 - 0 0 9 - 0 0 0 |
| 150-21-010-000    | 10   | RIGHT SIDE BOARD                | 39.95 | 1 5 0 - 2 1 - 0 1 0 - 0 0 0 |
| 150-21-012-000    | 12   | FRONT BOARD                     | 89.95 | 1 5 0 - 2 1 - 0 1 2 - 0 0 0 |
| 150-21-016-000    | 16   | FRONT LEFT DECORATE BOARD       | 19.95 | 1 5 0 - 2 1 - 0 1 6 - 0 0 0 |
| 150-21-017-000    | 17   | FRONT RIGHT DECORATE BOARD      | 19.95 | 1 5 0 - 2 1 - 0 1 7 - 0 0 0 |
| 150-21-019-000    | 19   | LEFT AIR-GUIDE COVER            | 29.95 | 1 5 0 - 2 1 - 0 1 9 - 0 0 0 |
| 150-21-020-000    | 20   | RIGHT AIR-GUIDE COVER           | 29.95 | 1 5 0 - 2 1 - 0 2 0 - 0 0 0 |
| 150-21-021-000    | 21   | LEFT DECORATIVE COVER           | 69.95 | 1 5 0 - 2 1 - 0 2 1 - 0 0 0 |
| 150-21-022-000    | 22   | RIGHT DECORATIVE COVER          | 69.95 | 1 5 0 - 2 1 - 0 2 2 - 0 0 0 |
| 150-21-026-000    | 26   | DECORATE CONNECTING BOARD BELOW | 19.95 | 1 5 0 - 2 1 - 0 2 6 - 0 0 0 |
| 150-21-028-000    | 28   | DECORATE CONNECTING BOARD       | 49.95 | 1 5 0 - 2 1 - 0 2 8 - 0 0 0 |



| MOTOFINO MF QT-21 |      |                                  |       |                             |
|-------------------|------|----------------------------------|-------|-----------------------------|
| PART NUMBER       | REF. | DESCRIPTION                      | MSRP  | PRODUCT CODE                |
| 150-21-029-000    | 1    | STORAGE BOX                      | 69.95 | 1 5 0 - 2 1 - 0 2 9 - 0 0 0 |
| 150-21-031-000    | 3    | CARBURETOR INSPECTING HOLE COVER | 14.95 | 1 5 0 - 2 1 - 0 3 1 - 0 0 0 |
| 150-21-032-000    | 4    | FOOTREST                         | 129   | 1 5 0 - 2 1 - 0 3 2 - 0 0 0 |
| 150-21-033-000    | 5    | COVER, BATTERY                   | 12.95 | 1 5 0 - 2 1 - 0 3 3 - 0 0 0 |
| 150-21-037-000    | 9    | CENTRAL PLASTIC COVER            | 24.95 | 1 5 0 - 2 1 - 0 3 7 - 0 0 0 |
| 150-21-039-000    | 11   | FRONT STORAGE BOX                | 129   | 1 5 0 - 2 1 - 0 3 9 - 0 0 0 |
| 150-21-040-000    | 12   | FRONT STORAGE BOX COVER          | 24.95 | 1 5 0 - 2 1 - 0 4 0 - 0 0 0 |
| 150-21-045-000    | 17   | REAR FENDER                      | 34.95 | 1 5 0 - 2 1 - 0 4 5 - 0 0 0 |
| 150-21-047-000    | 19   | FRONT PART, FRAME FENDER         | 14.95 | 1 5 0 - 2 1 - 0 4 7 - 0 0 0 |
| 150-21-048-000    | 20   | REAR PART, FRAME FENDER          | 29.95 | 1 5 0 - 2 1 - 0 4 8 - 0 0 0 |
| 150-21-051-000    | 23   | FRONT FENDER                     | 49.95 | 1 5 0 - 2 1 - 0 5 1 - 0 0 0 |
| 150-21-053-000    | 25   | REAR INNER FENDER                | 34.95 | 1 5 0 - 2 1 - 0 5 3 - 0 0 0 |
| 150-21-054-000    | 26   | BRACKET                          | 14.95 | 1 5 0 - 2 1 - 0 5 4 - 0 0 0 |
| 150-21-310-000    | 30   | COVER, VIN NO.                   | 5.95  | 1 5 0 - 2 1 - 3 1 0 - 0 0 0 |

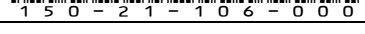

MOTOFINO MF QT-21

| PART NUMBER    | REF. | DESCRIPTION                    | MSRP  | PRODUCT CODE   |
|----------------|------|--------------------------------|-------|--|
| 150-21-058-000 | 1    | METER ASSY.                    | 89.95 | <br>1 5 0 - 2 1 - 0 5 8 - 0 0 0 |
| 150-21-065-000 | 1    | HEADLIGHT ASSY.                | 99.95 | <br>1 5 0 - 2 1 - 0 6 5 - 0 0 0 |
| 150-21-073-000 | 1    | LEFT POSITION LIGHT ASSY       | 21.95 | <br>1 5 0 - 2 1 - 0 7 3 - 0 0 0 |
| 150-21-074-000 | 2    | RIGHT POSITION LIGHT ASSY      | 21.95 | <br>1 5 0 - 2 1 - 0 7 4 - 0 0 0 |
| 150-21-082-000 | 10   | TAIL LAMP                      | 79.95 | <br>1 5 0 - 2 1 - 0 8 2 - 0 0 0 |
| 150-21-095-000 | 1    | FRONT LEFT TURNING LAMP ASSY.  | 21.95 | <br>1 5 0 - 2 1 - 0 9 5 - 0 0 0 |
| 150-21-096-000 | 2    | FRONT RIGHT TURNING LAMP ASSY. | 21.95 | <br>1 5 0 - 2 1 - 0 9 6 - 0 0 0 |
| 150-21-106-000 | 12   | LICENSE LAMP                   | 21.95 | <br>1 5 0 - 2 1 - 1 0 6 - 0 0 0 |



MOTOFINO MF QT-21



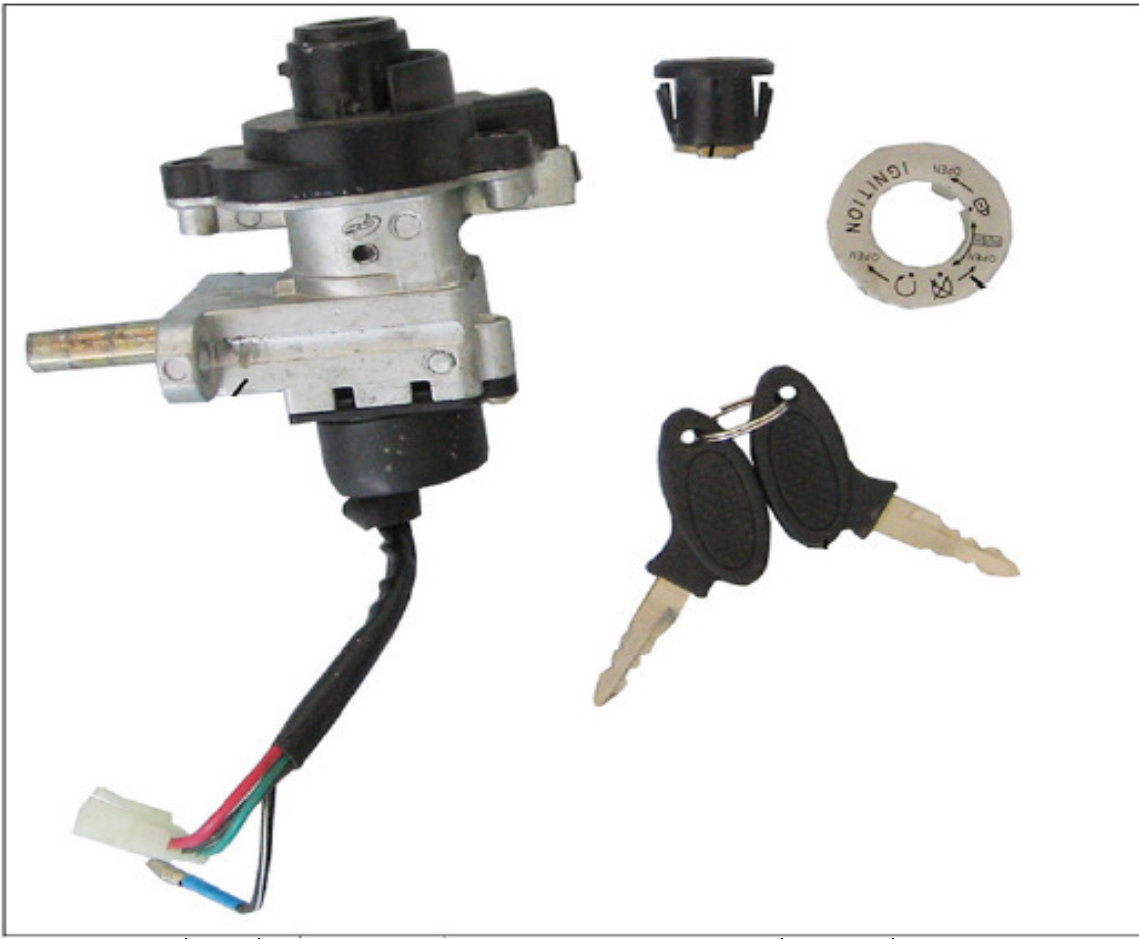



| PART NUMBER    | REF. | DESCRIPTION | MSRP  | PRODUCT CODE   |
|----------------|------|-------------|-------|--|
| 150-21-309-000 | 6    | LOCKY ASSY  | 89.95 | <br>1 5 0 - 2 1 - 3 0 9 - 0 0 0 |



MOTOFINO MF QT-21



| PART NUMBER    | REF. | DESCRIPTION               | MSRP  | PRODUCT CODE                |
|----------------|------|---------------------------|-------|-----------------------------|
| 150-21-116-000 | 1    | SEAT                      | 119   | 1 5 0 - 2 1 - 1 1 6 - 0 0 0 |
| 150-21-121-000 | 6    | LEFT FOOTPAD OF PASSENGER | 15.95 | 1 5 0 - 2 1 - 1 2 1 - 0 0 0 |
| 150-21-124-000 | 9    | SEAT LOCK HOLDER          | 12.95 | 1 5 0 - 2 1 - 1 2 4 - 0 0 0 |
| 150-21-126-000 | 11   | SEAT LOCK FIXING BOARD    | 12.95 | 1 5 0 - 2 1 - 1 2 6 - 0 0 0 |
| 150-21-128-000 | 13   | PASSENGER RIGHT FOOTREST  | 15.95 | 1 5 0 - 2 1 - 1 2 8 - 0 0 0 |
| 150-21-129-000 | 14   | REAR LEFT MIRROR          | 19.95 | 1 5 0 - 2 1 - 1 2 9 - 0 0 0 |
| 150-21-130-000 | 15   | REAR RIGHT MIRROR         | 19.95 | 1 5 0 - 2 1 - 1 3 0 - 0 0 0 |
| 150-21-131-000 | 16   | LICENSE PLATE BRACKET     | 12.95 | 1 5 0 - 2 1 - 1 3 1 - 0 0 0 |
| 150-21-132-000 | 17   | SIDE REFLECTOR            | 4.95  | 1 5 0 - 2 1 - 1 3 2 - 0 0 0 |
| 150-21-133-000 | 18   | REAR REFLECTOR            | 4.95  | 1 5 0 - 2 1 - 1 3 3 - 0 0 0 |



| MOTOFINO MF QT-21 |      |                                  |       |   |
|-------------------|------|----------------------------------|-------|---|
| PART NUMBER       | REF. | DESCRIPTION                      | MSRP  | PRODUCT CODE  |
| 150-21-135-000    | 1    | FUEL TANK                        | 59.95 |  |
| 150-21-136-000    | 2    | CAP COMP FUEL FILLER             | 12.95 |  |
| 150-21-137-000    | 3    | FUEL SENSOR                      | 14.95 |  |
| 150-21-138-000    | 4    | CAP COMP FUEL FILLER PRESS BOARD | 6.95  |  |
| 150-21-142-000    | 8    | FILTER                           | 4.95  |  |
| 150-21-143-000    | 9    | FUEL COCK                        | 39.95 |  |
| 150-21-145-000    | 11   | FUEL SENSOR SEAL                 | 6.95  |  |



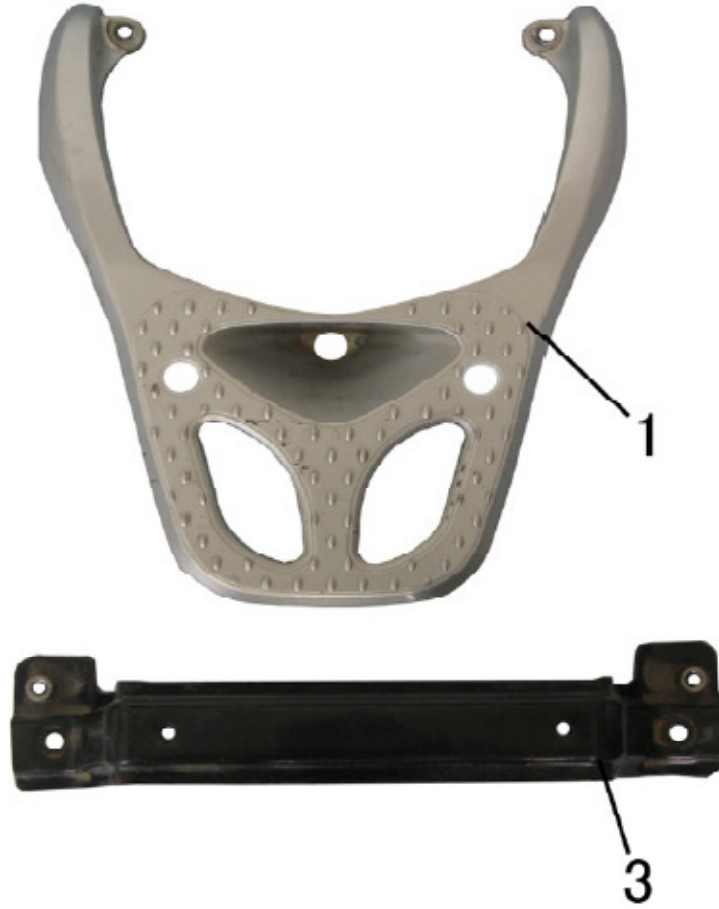

MOTOFINO MF QT-21

| PART NUMBER    | REF. | DESCRIPTION             | MSRP  | PRODUCT CODE   |
|----------------|------|-------------------------|-------|--|
| 150-21-146-000 | 1    | REAR CARRRIER           | 69.95 | <br>1 5 0 - 2 1 - 1 4 6 - 0 0 0 |
| 150-21-148-000 | 3    | FULE BOX PRESSURE BOARD | 19.95 | <br>1 5 0 - 2 1 - 1 4 8 - 0 0 0 |



MOTOFINO MF QT-21

| PART NUMBER    | REF. | DESCRIPTION              | MSRP  | PRODUCT CODE   |
|----------------|------|--------------------------|-------|--|
| 150-21-150-000 | 1    | MUFFLER ASSY             | 139   | <br>1 5 0 - 2 1 - 1 5 0 - 0 0 0 |
| 150-21-152-000 | 3    | MUFFLER PROTECTING BOARD | 24.95 | <br>1 5 0 - 2 1 - 1 5 2 - 0 0 0 |
| 150-21-153-000 | 4    | HEAT SHEILD              | 19.95 | <br>1 5 0 - 2 1 - 1 5 3 - 0 0 0 |

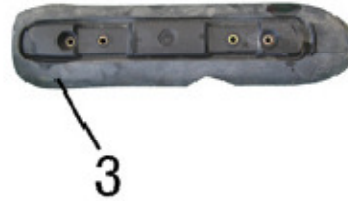



MOTOFINO MF QT-21

| PART NUMBER    | REF. | DESCRIPTION           | MSRP  | PRODUCT CODE                |
|----------------|------|-----------------------|-------|-----------------------------|
| 150-21-161-000 | 1    | FRAME ASSY.           | 225   | 1 5 0 - 2 1 - 1 6 1 - 0 0 0 |
| 150-21-162-000 | 2    | CRADLE                | 69.95 | 1 5 0 - 2 1 - 1 6 2 - 0 0 0 |
| 150-21-165-000 | 5    | MOTOR MOUNT BOLT      | 12.95 | 1 5 0 - 2 1 - 1 6 5 - 0 0 0 |
| 150-21-167-000 | 7    | MAIN STAND            | 59.95 | 1 5 0 - 2 1 - 1 6 7 - 0 0 0 |
| 150-21-168-000 | 8    | SPRING, MAIN STAND    | 5.95  | 1 5 0 - 2 1 - 1 6 8 - 0 0 0 |
| 150-21-173-000 | 13   | SIDE STAND            | 24.95 | 1 5 0 - 2 1 - 1 7 3 - 0 0 0 |
| 150-21-174-000 | 14   | SIDE STAND SPRING     | 5.95  | 1 5 0 - 2 1 - 1 7 4 - 0 0 0 |
| 150-21-176-000 | 16   | INTEGRATE FIXED FRAME | 39.95 | 1 5 0 - 2 1 - 1 7 6 - 0 0 0 |

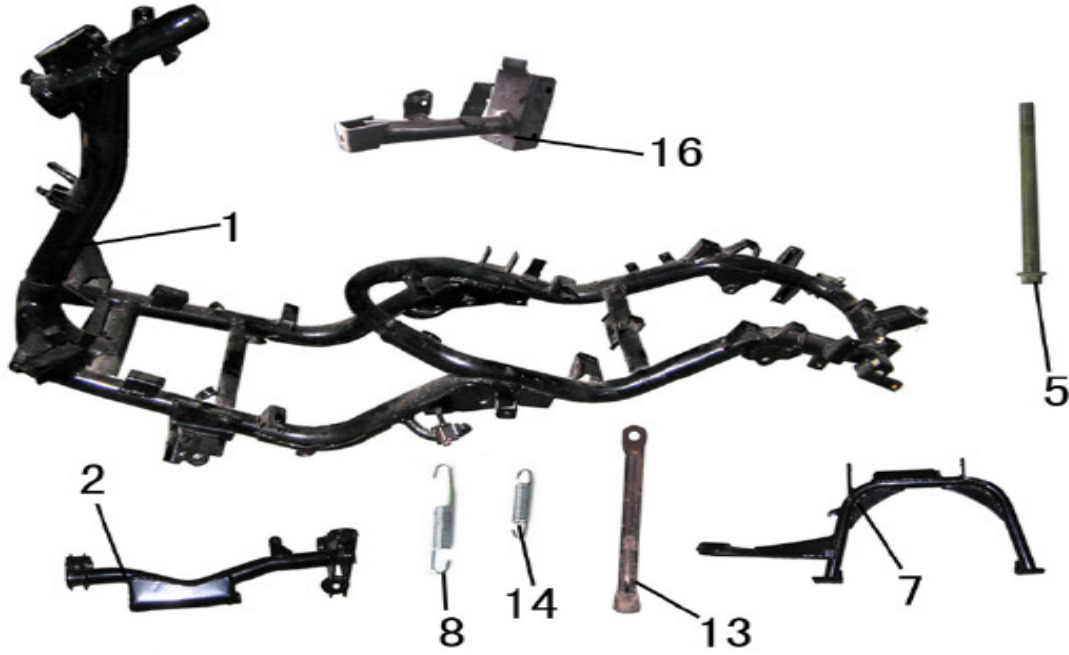





MOTOFINO MF QT-21

| PART NUMBER    | REF. | DESCRIPTION                | MSRP  | PRODUCT CODE                |
|----------------|------|----------------------------|-------|-----------------------------|
| 150-21-180-000 | 2    | FRONT TIRE 100/80/16       | 69.95 | 1 5 0 - 2 1 - 1 8 0 - 0 0 0 |
| 150-21-181-000 | 3    | FRONT RIM ASSY             | 149   | 1 5 0 - 2 1 - 1 8 1 - 0 0 0 |
| 150-21-186-000 | 8    | SPACER 12.5×20×34          | 6.95  | 1 5 0 - 2 1 - 1 8 6 - 0 0 0 |
| 150-21-187-000 | 9    | FRONT WHEEL AXIS 12 X 24.5 | 16.95 | 1 5 0 - 2 1 - 1 8 7 - 0 0 0 |
| 150-21-188-000 | 10   | BOLT M12                   | 1.95  | 1 5 0 - 2 1 - 1 8 8 - 0 0 0 |
| 150-21-189-000 | 11   | AIR VALVE                  | 6.5   | 1 5 0 - 2 1 - 1 8 9 - 0 0 0 |
| 150-21-190-000 | 12   | COUNTER                    | 39.95 | 1 5 0 - 2 1 - 1 9 0 - 0 0 0 |



MOTOFINO MF QT-21

| PART NUMBER    | REF. | DESCRIPTION         | MSRP  | PRODUCT CODE  |
|----------------|------|---------------------|-------|---|
| 150-21-192-000 | 2    | AXLE NUT            | 3.95  |  1 5 0 - 2 1 - 1 9 2 - 0 0 0 |
| 150-21-193-000 | 3    | RIM , REAR. WHEEL   | 149   |  1 5 0 - 2 1 - 1 9 3 - 0 0 0 |
| 150-21-194-000 | 4    | AIR. VALVE          | 6.5   |  1 5 0 - 2 1 - 1 9 4 - 0 0 0 |
| 150-21-195-000 | 5    | REAR TIRE 110/80/16 | 69.95 |  1 5 0 - 2 1 - 1 9 5 - 0 0 0 |



5



3



4





2

MOTOFINO MF QT-21

| PART NUMBER    | REF. | DESCRIPTION               | MSRP  | PRODUCT CODE                |
|----------------|------|---------------------------|-------|-----------------------------|
| 150-21-196-000 | 1    | HANDLE BAR                | 59.95 | 1 5 0 - 2 1 - 1 9 6 - 0 0 0 |
| 150-21-200-000 | 5    | LEFT GRIP                 | 10.95 | 1 5 0 - 2 1 - 2 0 0 - 0 0 0 |
| 150-21-201-000 | 6    | THROTTLE GRIP             | 11.95 | 1 5 0 - 2 1 - 2 0 1 - 0 0 0 |
| 150-21-202-000 | 7    | RIGHT SWITCH ASSY         | 49.95 | 1 5 0 - 2 1 - 2 0 2 - 0 0 0 |
| 150-21-203-000 | 8    | LEFT SWITCH ASSY          | 49.95 | 1 5 0 - 2 1 - 2 0 3 - 0 0 0 |
| 150-21-204-000 | 9    | STEERING STEM/TRIPLE TREE | 129   | 1 5 0 - 2 1 - 2 0 4 - 0 0 0 |
| 150-21-205-000 | 10   | FR. L. SHOCK ABSORBER     | 79.95 | 1 5 0 - 2 1 - 2 0 5 - 0 0 0 |
| 150-21-206-000 | 11   | FR. R. SHOCK ABSORBER     | 79.95 | 1 5 0 - 2 1 - 2 0 6 - 0 0 0 |
| 150-21-208-000 | 13   | CLIP                      | 7.95  | 1 5 0 - 2 1 - 2 0 8 - 0 0 0 |
| 150-21-209-000 | 14   | CLIP                      | 3.95  | 1 5 0 - 2 1 - 2 0 9 - 0 0 0 |
| 150-21-210-000 | 15   | STEERING STEM BEARING SET | 39.95 | 1 5 0 - 2 1 - 2 1 0 - 0 0 0 |





MOTOFINO MF QT-21

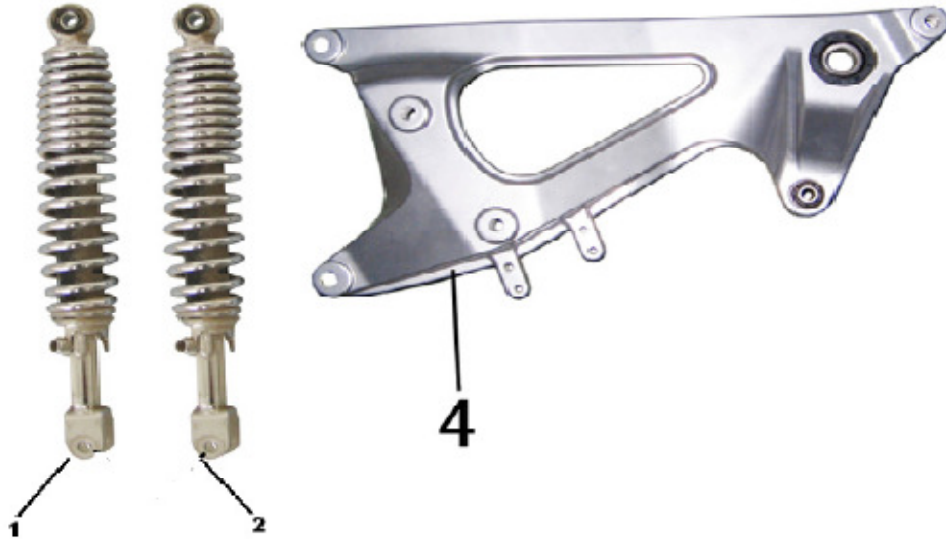

| PART NUMBER    | REF. | DESCRIPTION      | MSRP  | PRODUCT CODE   |
|----------------|------|------------------|-------|--|
| 150-21-217-L   | 1    | REAR ABSORBER -L | 59.95 | <br>1 5 0 - 2 1 - 2 1 7 - L     |
| 150-21-218-R   | 2    | REAR ABSORBER -R | 59.95 | <br>1 5 0 - 2 1 - 2 1 8 - R     |
| 150-21-220-000 | 4    | MOUNTING BOARD   | 79.95 | <br>1 5 0 - 2 1 - 2 2 0 - 0 0 0 |



MOTOFINO MF QT-21

| PART NUMBER    | REF. | DESCRIPTION      | MSRP  | PRODUCT CODE   |
|----------------|------|------------------|-------|--|
| 150-21-224-000 | 1    | AIR FILTER ASSY. | 69.95 | <br>1 5 0 - 2 1 - 2 2 4 - 0 0 0 |
| 150-21-228-000 | 5    | AIR FILTER       | 19.95 | <br>1 5 0 - 2 1 - 2 2 8 - 0 0 0 |



| MOTOFINO MF QT-21 |      |                   |       |  |
|-------------------|------|-------------------|-------|--|
| PART NUMBER       | REF. | DESCRIPTION       | MSRP  | PRODUCT CODE   |
| 150-21-237-000    | 1    | SEAT CABLE        | 29.95 | <br>1 5 0 - 2 1 - 2 3 7 - 0 0 0 |
| 150-21-238-000    | 2    | THROTTLE CABLE    | 29.95 | <br>1 5 0 - 2 1 - 2 3 8 - 0 0 0 |
| 150-21-239-000    | 3    | SPEEDOMETER CABLE | 29.95 | <br>1 5 0 - 2 1 - 2 3 9 - 0 0 0 |







MOTOFINO MF QT-21

| PART NUMBER    | REF. | DESCRIPTION             | MSRP  | PRODUCT CODE                |
|----------------|------|-------------------------|-------|-----------------------------|
| 150-21-240-000 | 1    | HARNES                  | 59.95 | 1 5 0 - 2 1 - 2 4 0 - 0 0 0 |
| 150-21-241-000 | 2    | FLASHER-BLINKER RELAY   | 14.95 | 1 5 0 - 2 1 - 2 4 1 - 0 0 0 |
| 150-21-242-000 | 3    | IGNITION COIL           | 29.95 | 1 5 0 - 2 1 - 2 4 2 - 0 0 0 |
| 150-21-246-000 | 7    | STARTER RELAY/ SOLENOID | 24.95 | 1 5 0 - 2 1 - 2 4 6 - 0 0 0 |
| 150-21-247-000 | 8    | CDI                     | 34.95 | 1 5 0 - 2 1 - 2 4 7 - 0 0 0 |
| 150-21-248-000 | 9    | VOLTAGE REGULATOR       | 34.95 | 1 5 0 - 2 1 - 2 4 8 - 0 0 0 |
| 150-21-251-000 | 12   | HORN                    | 12.95 | 1 5 0 - 2 1 - 2 5 1 - 0 0 0 |



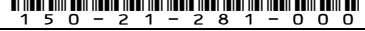

MOTOFINO MF QT-21

| PART NUMBER    | REF. | DESCRIPTION                 | MSRP  | PRODUCT CODE   |
|----------------|------|-----------------------------|-------|--|
| 150-21-257-000 | 3    | HYDRAULIC BRAKE HOSE        | 29.95 | <br>1 5 0 - 2 1 - 2 5 7 - 0 0 0 |
| 150-21-260-000 | 6    | FRONT BRAKE HANDLE/RIGHT    | 14.95 | <br>1 5 0 - 2 1 - 2 6 0 - 0 0 0 |
| 150-21-263-000 | 9    | FRONT BRAKE MASTER CYLINDER | 49.95 | <br>1 5 0 - 2 1 - 2 6 3 - 0 0 0 |
| 150-21-267-000 | 13   | FRONT BRAKE CALIPER         | 59.95 | <br>1 5 0 - 2 1 - 2 6 7 - 0 0 0 |
| 150-21-271-000 | 17   | FRONT BRAKE PAD SET         | 29.95 | <br>1 5 0 - 2 1 - 2 7 1 - 0 0 0 |
| 150-21-281-000 | 27   | FRONT BRAKE ROTOR           | 49.95 | <br>1 5 0 - 2 1 - 2 8 1 - 0 0 0 |

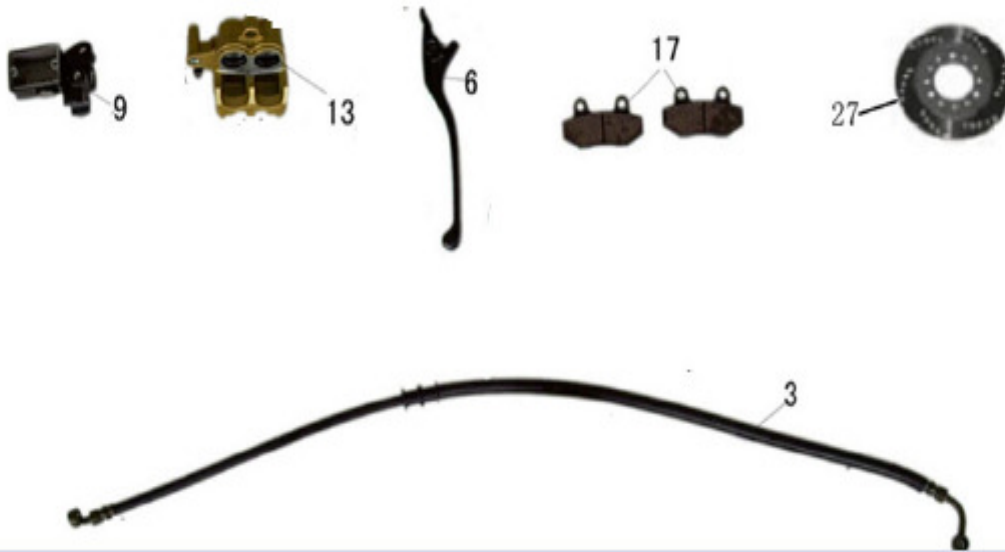

MOTOFINO MF QT-21

| PART NUMBER    | REF. | DESCRIPTION                | MSRP  | PRODUCT CODE                |
|----------------|------|----------------------------|-------|-----------------------------|
| 150-21-285-000 | 2    | REAR BRAKE MASTER CYLINDER | 49.95 | 1 5 0 - 2 1 - 2 8 5 - 0 0 0 |
| 150-21-287-000 | 4    | REAR BRAKE LEVER/ LEFT     | 14.95 | 1 5 0 - 2 1 - 2 8 7 - 0 0 0 |
| 150-21-288-000 | 5    | REAR BRAKE PAD SET         | 29.95 | 1 5 0 - 2 1 - 2 8 8 - 0 0 0 |
| 150-21-304-000 | 21   | REAR BRAKE CALIPER         | 59.95 | 1 5 0 - 2 1 - 3 0 4 - 0 0 0 |
| 150-21-306-000 | 23   | REAR BRAKE HYDRAULIC HOSE  | 39.95 | 1 5 0 - 2 1 - 3 0 6 - 0 0 0 |
| 150-21-307-000 | 24   | REAR BRAKE ROTOR           | 49.95 | 1 5 0 - 2 1 - 3 0 7 - 0 0 0 |

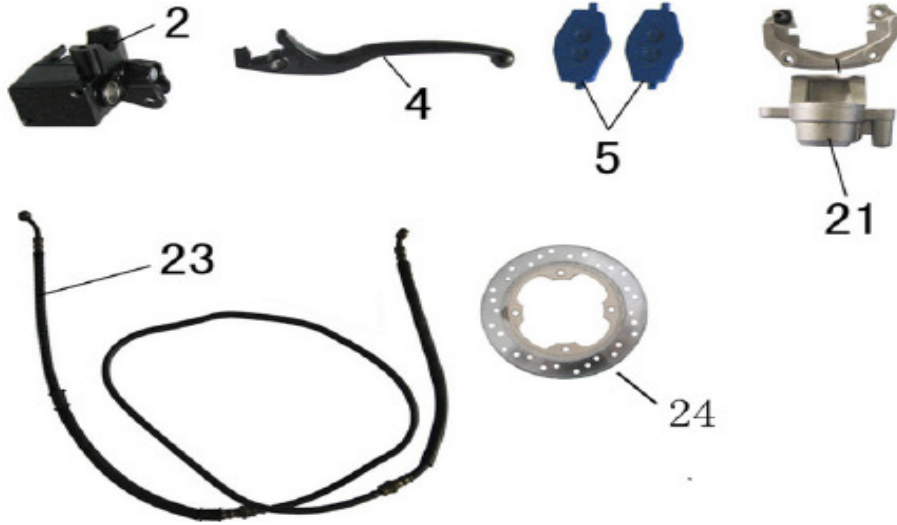

MOTOFINO MF QT-21

| PART NUMBER   | REF. | DESCRIPTION  | MSRP  | PRODUCT CODE   |
|---------------|------|--------------|-------|--|
| 150-3-553-000 | 3    | BATTERY ASSY | 79.95 | <br>1 5 0 - 3 - 5 5 3 - 0 0 0 |

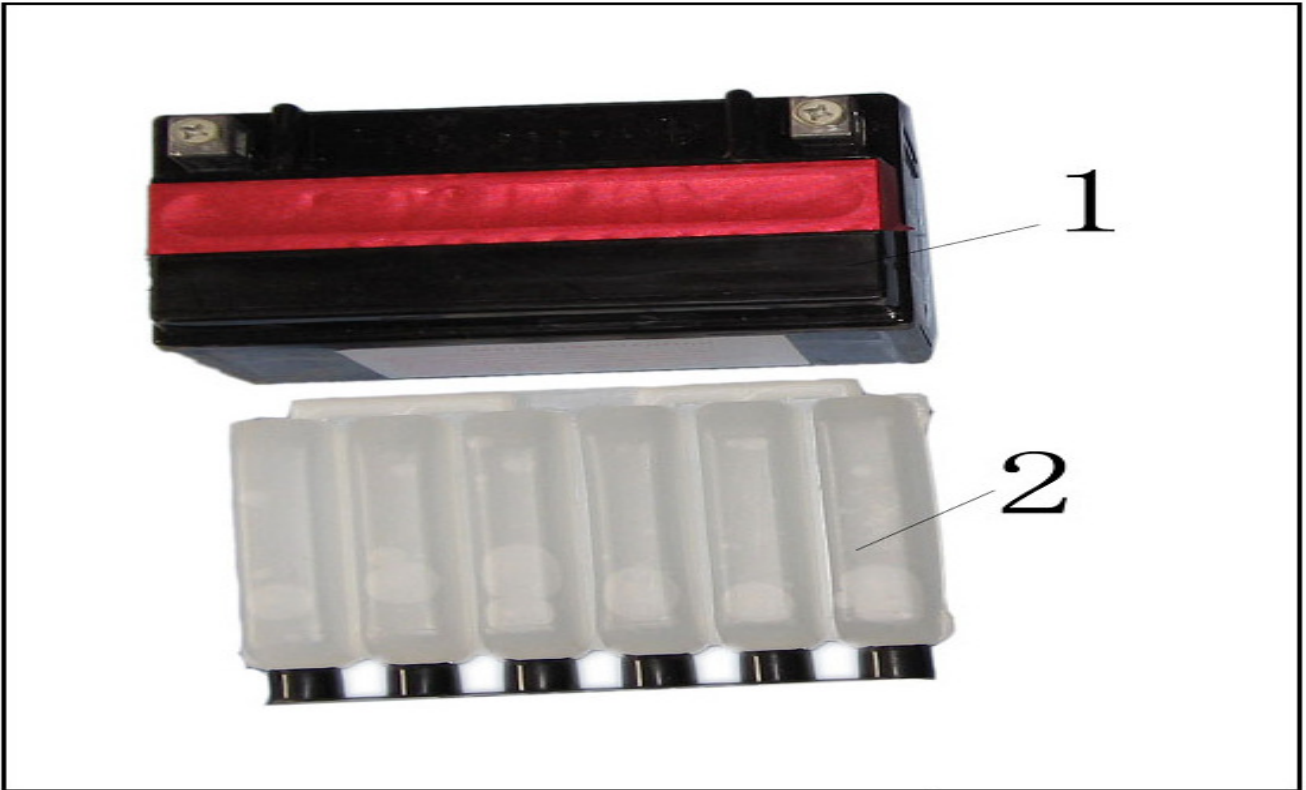

3